

# Multilingual Version

[English](#)

[日本語](#)

[中文](#)

[Français](#)

[Español](#)

[Italiano](#)

## QUICK GUIDE

Please read instructions thoroughly before operation and retain it for future reference. Online manual download:  
[www.surveillance-download.com/user/m359a.swf](http://www.surveillance-download.com/user/m359a.swf)

## PACKAGE CONTENT

Before starting to set up your camera, please make sure items below in your box:

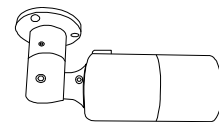

Camera

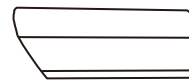

Sun Shield

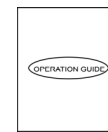

Quick guide

### For selected models only:



Screws



Wall  
Plugs



Wrench



Desiccant

## CABLE OVERVIEW

Below is an overview of various cables that can be used with the camera. Besides, it is followed by a table, which offers simple descriptions of cable connection.

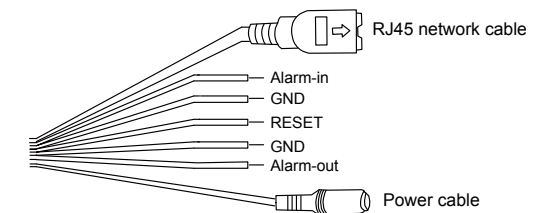

Cable	Description
Power cable	DC12V power supply.
RJ45 network cable*	Connect it to a RJ45 cable.
GND	Ground wire
Alarm-in	Reserved for external alarm device connection
Alarm-out	Reserved for external alarm device connection
RESET	Remove the insulating coating of wire, and twist it with a ground wire together to reset default camera

\* For PoE (IEEE802.3af) installation, make sure your network cable has the maximum cable resistance of  $20\Omega$ , such as CAT.5e or CAT.6 cables, to conform to the standard of IEEE802.3af.

## INSTALLATION

Step1: Locate where you want to install this camera, and fasten the camera to the ceiling or wall.

**Note:** It's recommended to slightly loosen the screw on the bracket as indicated below to move the camera down a little bit. It's easier for bracket installation to the ceiling or wall.

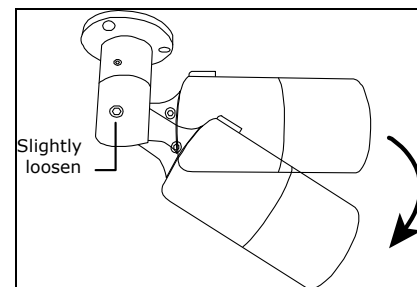

Step2: Adjust the viewing angle of the camera, as indicated below.

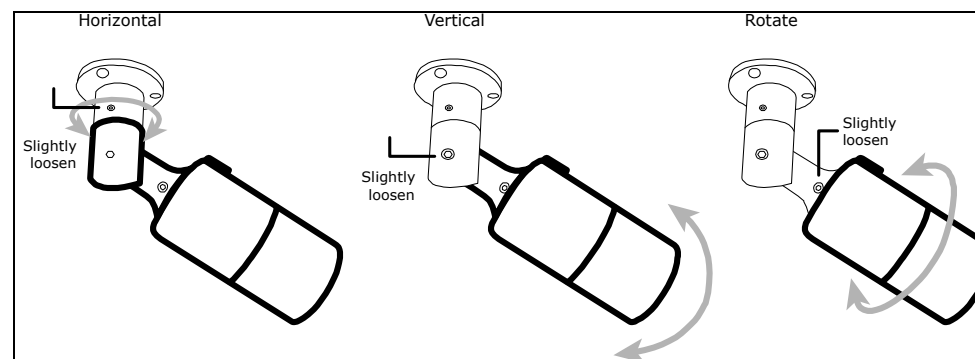

Step3: Power on the camera, and follow the steps in the next section "ADJUST FOCAL LENGTH & FOCUS" if necessary.

Step4: Slide the sun shield to the camera, and fasten it with the supplied screw.

**Note:** In order to make the best performance, please adjust the angle of IR shift up and down within 30 degree respectively, left and right within 15 degree respectively.

## ADJUST FOCAL LENGTH & FOCUS

**Note:** The appropriate temperature for focus adjustment is  $0^{\circ}\text{C} \sim 40^{\circ}\text{C}$ , and prevent adjusting in moisture environment.

Step1: Loosen the screw on the sun shield, and slide the shield to remove it (if the shield is fastened to the camera).

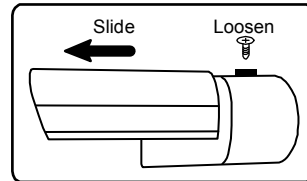

Then, rotate the front cover to reveal the inner of the camera.

Step2: Remove two bags of desiccants placed in the camera.

**Note:** Remember where these bags were placed. New desiccants will be placed into the camera later in Step4.

Step3: Find two handles in the camera to adjust focal length and focus. Move the handle near to the main board first to find the best surveillance area, and move the hand near to the lens to adjust the sharpness of the image.

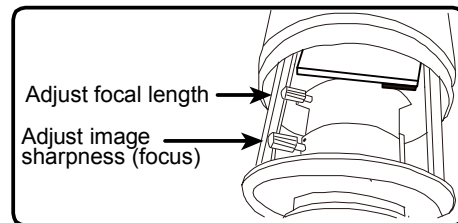

Step4: Open the new bags of desiccants supplied in the package to replace the old ones within 30 seconds, or the desiccants might absorb too much moisture in the air.

**Tip:** To know if the desiccants are ok, find the desiccant colored in the bag against light. If the color of the desiccant is yellow, this bag is ok and ready to use. If the color of the desiccant is dark green or even red, please replace this bag with a new one.

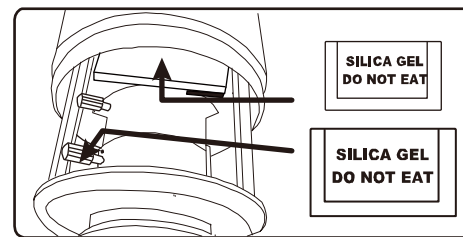

Step5: Place the front cover back.

Step6: Slide to mount the shield on the camera before tightening the screw.

## Insert Micro SD Card

**Only selected models are equipped with a micro SD card slot for local video recording.**

The data originally saved in the micro SD card (if any) will be removed after inserting it to the camera.

The camera doesn't support hot-swapping. Please insert or remove the micro SD card with power disconnected.

Please follow the directions in the below graphic to insert Micro SD card properly:

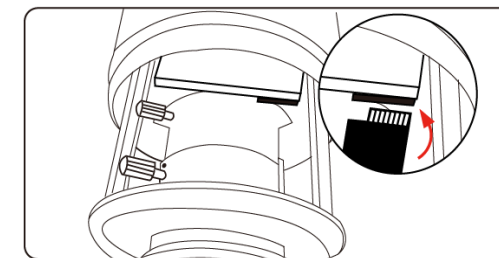

**Note:** It's recommended to use a pair of tweezers for inserting / removing Micro SD card.

## CAMERA CONFIGURATION

For advanced configuration of your camera, please be sure you have connected your camera to NVR as shown in "HD System Connection".

**Note:** It's recommended to connect the camera to the same brand's NVR to get the best performance. To use the camera individually, please refer to the camera's operation guide supplied in the CD to know how to configure this camera solely.

Step1: Connect PC to the HUB connected to your camera(s) with RJ45 network cable.

Step2: Search available devices with "IPScan.exe"; to download "IPScan.exe", please visit [www.surveillance-download.com/user/IPscan.zip](http://www.surveillance-download.com/user/IPscan.zip)

Step3: After searching, set your PC in the same network segment as the specific camera you want to access, such as "192.168.30.xxx" (xxx could be 0~255) in our example

Step4: Note down the IP address and port number of the camera you want to access, such as "192.168.30.1" and "88" in our example.

Step5: Open Internet Explorer on the PC, and enter the IP address and port number in the URL column to access the camera. The format is `http://ipaddress:portnum`, such as `http://192.168.30.1:88` in our example.

IP	Port	Type	Mac	
192.168.30.1	88	IP CAMERA (FIX)	00:19:94:25:78:4f	Configure
192.168.30.1	88	IP CAMERA (FIX)	00:18:94:25:77:4f	Upgrade
192.168.30.4	88	IP CAMERA (FIX)	00:17:94:25:76:4f	Scan
192.168.30.5	88	IP CAMERA (FIX)	00:16:94:25:75:4f	
192.168.30.6	88	IP CAMERA (FIX)	00:15:94:25:74:4f	
				Exit

# QUICK GUIDE

Please read instructions thoroughly before operation and retain it for future reference. Online manual download: [www.surveillance-download.com/user/m359a.swf](http://www.surveillance-download.com/user/m359a.swf)

## PACKAGE CONTENT

Before starting to set up your camera, please make sure items below in your box:

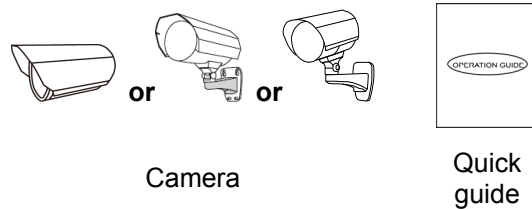

**For selected models only:**

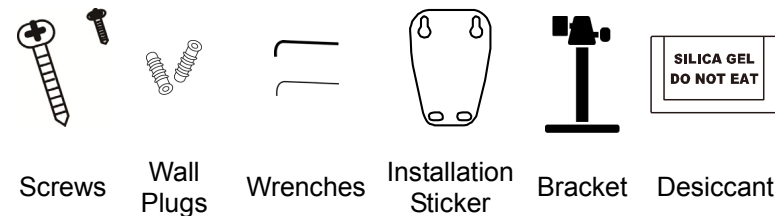

## INSTALLATION (Type 1)

- Step1: Fix the bracket to where you want to install the camera with the supplied three screws.
- Step2: Remove the Joint Lock from the bracket. Then, connect the Joint Lock to the backside of the camera.

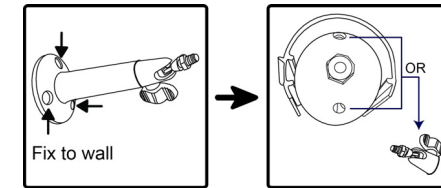

- Step3: Connect the camera with the Joint Lock connected to the bracket. After that, secure the Joint Lock to fix. Next, fix the shield on the camera by turning the supplied small screw into either hole on the camera.
- Step4: Connect the camera to power.

**Note:** In order to make the best performance, please adjust the angle of IR shift up and down within 30 degree respectively, left and right within 15 degree respectively.

## INSTALLATION (Type 2)

Step1: Paste the installation sticker on where you want to install the camera. Then, drill 4 screw holes as indicated on the sticker, and fasten two screws to the top as shown in the picture.

**Note:** Leave some space between the screws and wall to hook the bracket later.

Step2: Hang the camera at the screws you just fixed, and make sure the camera stays in place. Decide the cable direction (up / down) before you fasten the screws tight to the wall.

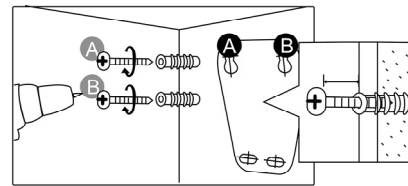

Step3: Fasten all screws to secure the bracket to the wall.

Step4: Adjust the vertical and horizontal angles of the camera with the supplied wrenches for a better viewing.

**Note:** To adjust the angle, for example the vertical angle. DO NOT loosen / fix one side of the screw to the end at once. Please do adjustment by taking turns on both sides till the angle is fixed. Otherwise, the angle of the camera might not be fixed.

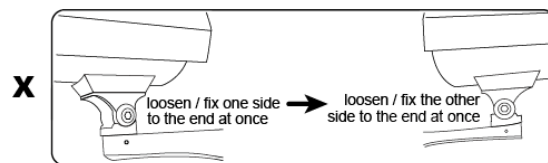

**Note:** In order to make the best performance, please adjust the angle of IR shift up and down within 30 degree respectively, left and right within 15 degree respectively.

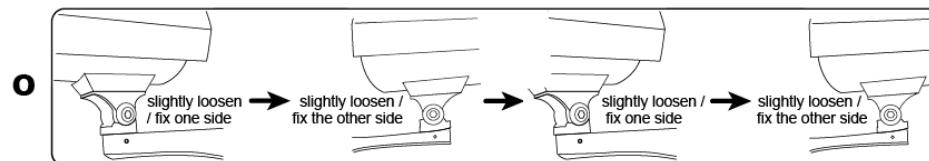

## CABLE OVERVIEW

Below is an overview of various cables that can be used with the camera. Besides, it is followed by a table, which offers simple descriptions of cable connection.

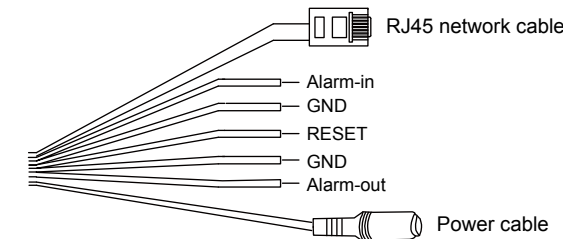

Cable	Description
Power cable	DC12V power supply.
RJ45 network cable*	Connect it to a RJ45 cable.
GND	Ground wire
Alarm-in	Reserved for external alarm device connection
Alarm-out	Reserved for external alarm device connection
RESET	Remove the insulating coating of wire, and twist it with a ground wire together to reset default camera

\* For PoE (IEEE802.3af) installation, make sure your network cable has the maximum cable resistance of 20Ω, such as CAT.5e or CAT.6 cables, to conform to the standard of IEEE802.3af.

## ADJUST FOCAL LENGTH & FOCUS (Selected Model Only)

**Note:** The appropriate temperature for focus adjustment is 0°C ~ 40°C, and prevent adjusting in moisture environment.

Step1: Loosen the screw, take the shield off your camera, and rotate the front cover to remove it

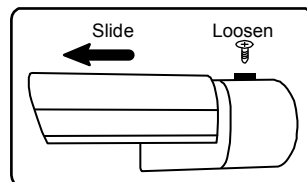

Step2: Remove two bags of desiccants placed in the camera.

**Note:** Remember where these bags were placed. New desiccants will be placed into the camera later in Step4.

Step3: Find two handles on the camera to adjust focal length and focus. Move the handle near to the main board first to find the best surveillance area, and move the hand near to the lens to adjust the sharpness of the image.

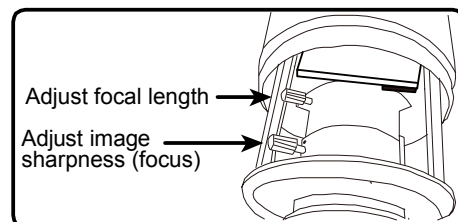

Step4: Open the new bag(s) of desiccants supplied in the package to replace the old one(s) within 30 seconds, or the desiccants might absorb too much moisture in the air.

**Tip:** To know if the desiccants are ok, find the desiccant colored in the bag against light. If the color of the desiccant is yellow, this bag is ok and ready to use. If the color of the desiccant is dark green or even red, please replace this bag with a new one.

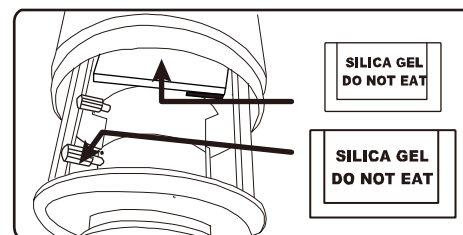

Step5: Place the front cover back and fasten it tightly.

Step6: Slide to mount the shield on the camera before tightening the screw.

## Insert Micro SD Card

Only selected models are equipped with a micro SD card slot for local video recording.

To insert a micro SD card, front cover should be removed. Before replacing the cover back, refer to Step4~6 in "ADJUST FOCAL LENGTH & FOCUS" about desiccants replacement.

The data originally saved in the micro SD card (if any) will be removed after inserting it to the camera.

The camera doesn't support hot-swapping. Please insert or remove the micro SD card with power disconnected.

Please follow the directions in the below graphic to insert Micro SD card properly:

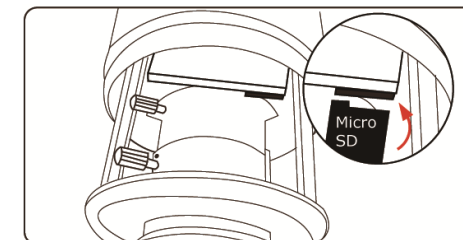

**Note:** It's recommended to use a pair of tweezers for inserting / removing Micro SD card.

## CAMERA CONFIGURATION

For advanced configuration of your camera, please be sure you have connected your camera to NVR as shown in "HD System Connection".

**Note:** It's recommended to connect the camera to the same brand's NVR to get the best performance. To use the camera individually, please refer to the camera's operation guide supplied in the CD to know how to configure this camera solely.

**Note:** If the temperature of the installation environment is under 0°C, 50 minutes or more will be needed for the camera to warm up.

Step1: Connect PC to the HUB connected to your camera(s) with RJ45 network cable.

Step2: Search available devices with "IPScan.exe"; to download "IPScan.exe", please visit [www.surveillance-download.com/user/IPscan.zip](http://www.surveillance-download.com/user/IPscan.zip)

Step3: After searching, set your PC in the same network segment as the specific camera you want to access, such as "192.168.30.xxx" (xxx could be 0~255) in our example

Step4: Note down the IP address and port number of the camera you want to access, such as "192.168.30.1" and "88" in our example.

Step5: Open Internet Explorer on the PC, and enter the IP address and port number in the URL column to access the camera. The format is http://ipaddress:portnum, such as <http://192.168.30.1:88> in our example.

IP	Port	Type	Mac	
192.168.30.1	88	IP CAMERA (FIX)	00:19:94:25:78:4f	Configure
192.168.30.1	88	IP CAMERA (FIX)	00:18:94:25:77:4f	Upgrade
192.168.30.1	88	IP CAMERA (FIX)	00:17:94:25:76:4f	Scan
192.168.30.4	88	IP CAMERA (FIX)	00:16:94:25:75:4f	
192.168.30.5	88	IP CAMERA (FIX)	00:15:94:25:74:4f	
192.168.30.6	88	IP CAMERA (FIX)	00:14:94:25:73:4f	



## クイック・ガイド

今後ご参考のため、この取扱説明書をよくお読みになった上、よく保管してください。オンラインマニュアルのダウンロード：  
[www.surveillance-download.com/user/m359a.swf](http://www.surveillance-download.com/user/m359a.swf)

## ■ パッケージの内容

カメラのセットアップを開始する前に、箱の中に以下のアイテムが揃っていることを確認してください：

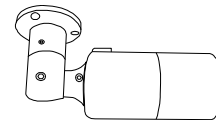

カメラ

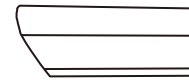

サンシールド

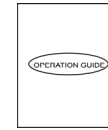

クイックガイド

### 上位モデルのみ：



ネジ

ウォール  
プラグ

レンチ



乾燥剤

## ■ ケーブル概要

以下は、カメラで使用することができる各種ケーブルの概要です。下の表は、ケーブル接続の簡単な説明を示します。

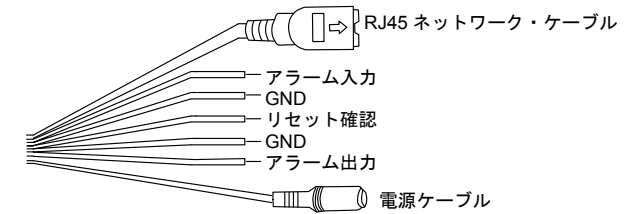

ケーブル	説明
電源ケーブル	DC12V 電源。
RJ45 ネットワーク・ケーブル*	それを RJ45 ケーブルに接続します。
GND	アース線
アラーム入力	外部アラーム装置接続のために予約されています
アラーム出力	外部アラーム装置接続のために予約されています
リセット確認	カメラをデフォルトにリセットするために、電線の絶縁被覆を外し、アース線と一緒にそれをねじってください

\* PoE (IEEE802.3af) の設置の場合は、ネットワークケーブルが、IEEE802.3af 規格を満たす CAT.5e または CAT.6 などの 20Ω の最大ケーブル抵抗を持つことを確認してください。

## ■ 設置

ステップ 1: このカメラを設置する場所を探し、カメラを天井または壁に固定します。

**注意：** 以下に示すように、少しカメラを下に移動できるよう、わずかにブラケットのネジを緩めることをお勧めします。これにより、天井や壁へのブラケット取り付けが簡単になります。

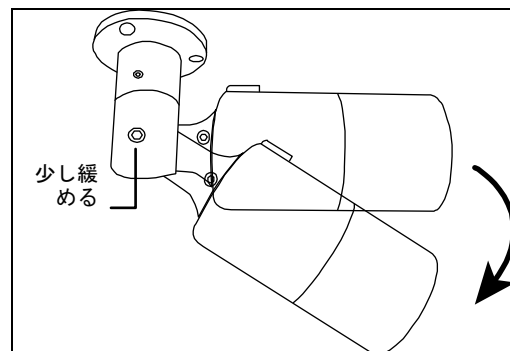

ステップ 2: 以下に示すように、カメラの視野角を調整します。

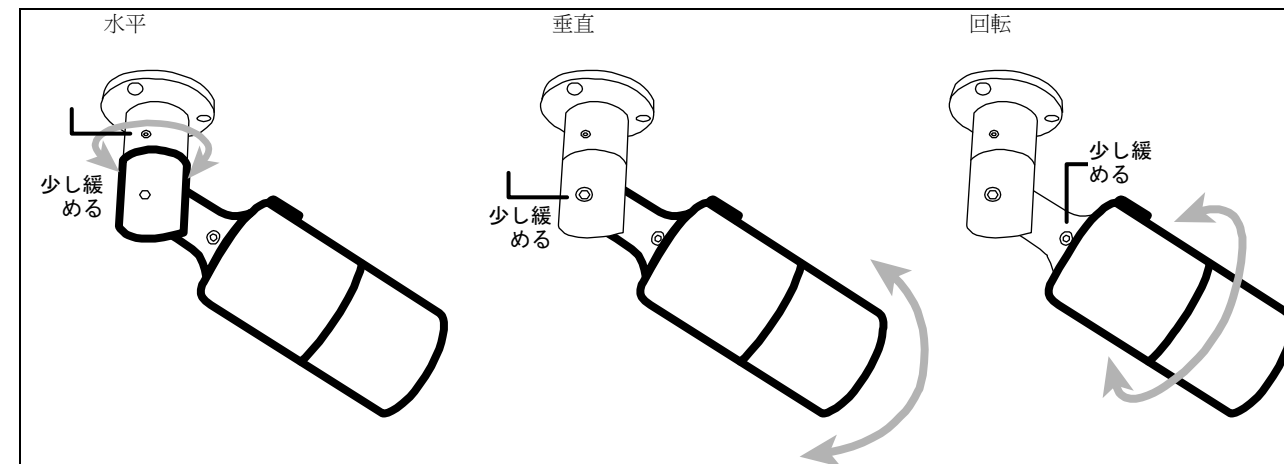

ステップ 3: 必要に応じて、カメラに電源を投入し、次のセクション「焦点距離およびフォーカスの調整」のステップに従います。

ステップ 4: カメラにサンシールドをスライドさせ、付属のネジで固定します。

## ■ 焦点距離およびフォーカスの調整

**注意：** フォーカス調整のための適切な温度は0℃～40℃です、また、湿度の高い環境での調整を避けてください。

ステップ 1: サンシールドのネジを緩め、それを取り外すためにシールドをスライドさせます(シールドがカメラに固定されている場合)。その後、フロントカバーを回転し、カメラの内部を開きます。

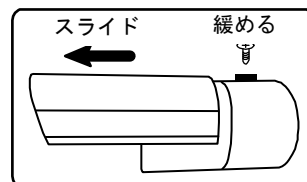

ステップ 2: カメラに配置された乾燥剤 2 袋を取り外します。

**注意：** これらの袋が配置されていた場所を覚えておきます。新しい乾燥剤は、後のステップ 4 において、カメラに配置されます。

ステップ 3: 焦点距離およびフォーカスを調整するための 2 本のハンドルをカメラの中で探します。最初にハンドルをメインボードの近くに動かし最高の監視領域を探し、そして、ハンドルをレンズの近くに動かし画像の鮮明さを調整します。

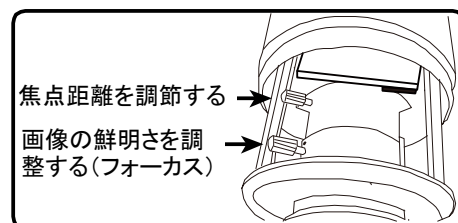

ステップ 4: パッケージに付属の乾燥剤の新しい袋を開き、30 秒以内に古い乾燥剤と交換します、そうしないと乾燥剤は空気中で多くの水分を吸収する可能性があります。

**ヒント：** 乾燥剤が正常であるかどうかを知るために、光に対して袋に着色された乾燥剤を確認します。乾燥剤の色が黄色の場合、この袋は正常であり、使用できます。乾燥剤の色が深い緑または赤の場合、この袋を新品と交換してください。

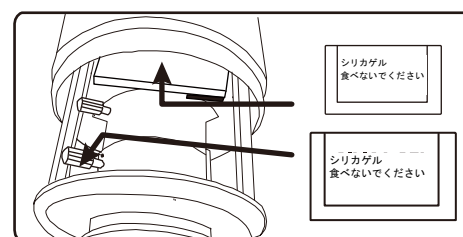

ステップ 5: フロントカバーを取り付けます。

ステップ 6: ネジを締める前に、カメラのシールドをスライドさせ取り付けます。

## ■ マイクロ SD カードの挿入

指定されたモデルのみが、ローカルビデオ録画用のマイクロ SD カード・スロットを装備しています。

最初にマイクロ SD カードに保存されていたデータは(もしある場合)、カードを挿入すると消去されます。

カメラはホット・スワップに対応していません。電源を切断した状態で、マイクロ SD カードを挿入または抜いて下さい。

マイクロ SD カードを正しく挿入するために、下図の指示に従ってください：

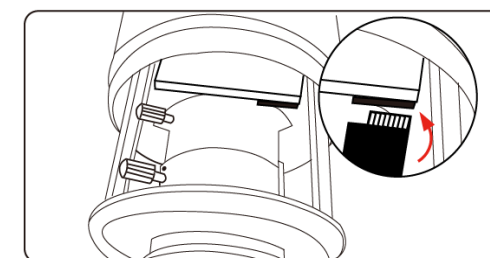

**注意：** マイクロ SD カードを取り出し/挿入するためのピンセットを使用することをお勧めします。

## ■ カメラの設定

お使いのカメラの詳細設定については、「HD システムとの接続」に示すように、NVR にカメラを接続していることを確認してください。

**注意：** 最高のパフォーマンスを得るために、同じブランドの NVR にカメラを接続することをお勧めします。個別にカメラを使用するには、CD で提供されるカメラの操作ガイドを参照し、このカメラを設定する方法を熟知してください。

ステップ 1: RJ45 ネットワーク・ケーブルを使い、お使いのカメラを接続したハブに PC を接続します。

ステップ 2: 「IPScan.exe」を使って利用可能なデバイスを検索します。「IPScan.exe」をダウンロードするには、[www.surveillance-download.com/user/IPscan.zip](http://www.surveillance-download.com/user/IPscan.zip) を参照して下さい

ステップ 3: 検索の後に、アクセスするカメラと同じネットワーク・セグメントにお使いの PC を設定します(例: 192.168.30.xxx [xxx は 0 ~255])。

ステップ 4: アクセスするカメラの IP アドレスならびにポート番号をメモします(例: 「192.168.30.1」、「88」)。

ステップ 5: PC 上で Internet Explorer を開き、URL カラムに IP アドレスのポート番号を入力して、カメラにアクセスします。フォーマットは、http://IP アドレス:ポート番号です(例: <http://192.168.30.1:88>)。

IP	Port	Type	Mac	
192.168.30.1	88	IP CAMERA (FIX)	00:19:94:25:78:4f	Configure
192.168.30.4	88	IP CAMERA (FIX)	00:18:94:25:77:4f	Upgrade
192.168.30.5	88	IP CAMERA (FIX)	00:17:94:25:76:4f	Scan
192.168.30.6	88	IP CAMERA (FIX)	00:16:94:25:75:4f	
			00:15:94:25:74:4f	
			00:14:94:25:73:4f	Exit

快速使用指南

在使用前請先閱讀本指南，並妥善保管本指南以利日後使用。

線上說明書下載位置：

[www.surveillance-download.com/user/m359a.swf](http://www.surveillance-download.com/user/m359a.swf)

■ 包裝明細

在開始使用本攝影機前，請先確認包裝內是否內含以下物品：



選用配件 (視機種而定)：

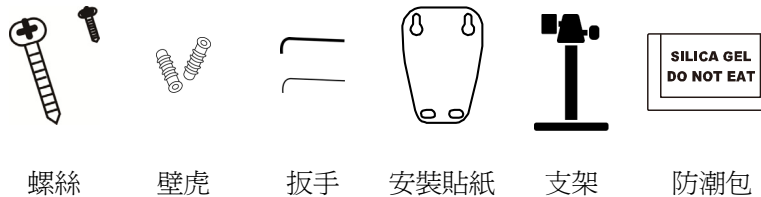

■ 安裝 (Type 1)

- 步驟 1：使用隨附螺絲，將支架固定在要安裝攝影機的位置。
- 步驟 2：將支架前端的連接處拆下，鎖到攝影機背後的螺絲孔。

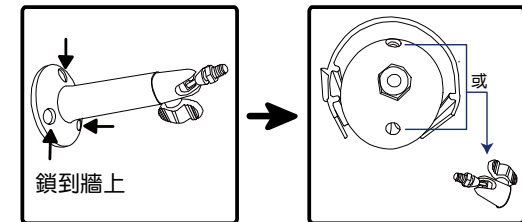

- 步驟 3：將攝影機鎖回支架，然後將連接處鎖緊。最後，使用隨附的小螺絲將攝影機的外遮罩鎖緊。
- 步驟 4：將攝影機上電。

■ 安裝 (Type 2)

步驟 1：將隨附的安裝貼紙貼到攝影機要安裝的位置。接著，依貼紙標示分別在四個位置鑽好孔，然後依下圖所示先在上方兩處鎖進螺絲。

備註：此處螺絲請暫勿鎖緊，稍後安裝需要掛支架。

步驟 2：將支架先掛在剛鎖好的螺絲上。先決定要走線的方向 (上或下)，然後再將螺絲鎖緊。

步驟 3：將支架固定在牆上。

步驟 4：使用隨附的扳手調整攝影機的垂直和水平視角。

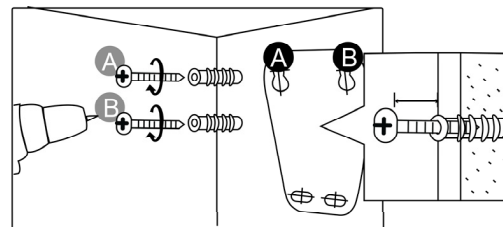

備註：在調整視角時，切勿一次就將螺絲鬆到底或鎖到底，請依序微調兩側螺絲，直到螺絲鎖緊為止。若一次就將螺絲鬆到底或鎖到底，螺絲可能會因為脫牙而鎖不緊。

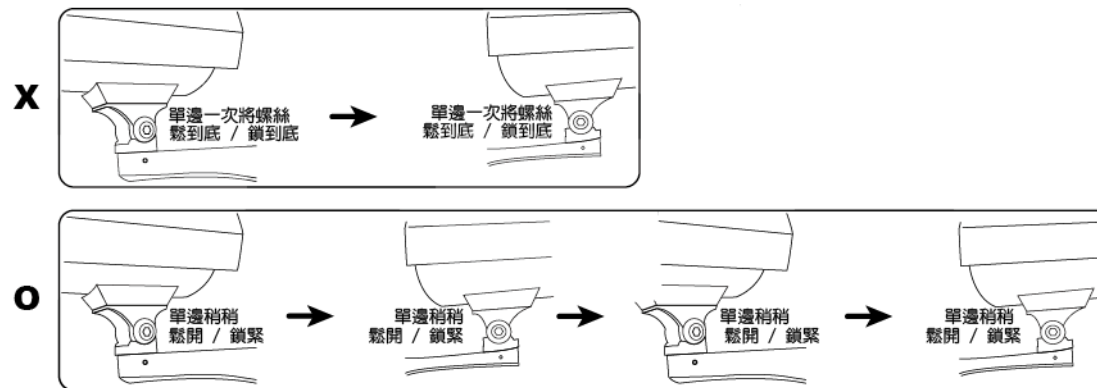

■ 線材說明

以下為攝影機的線材說明。

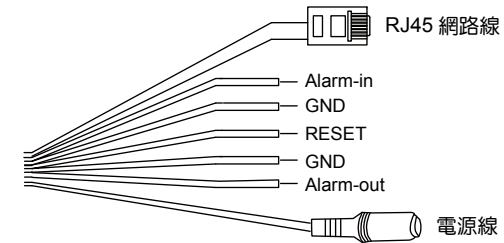

Cable	Description
電源線	DC12V 電源線和電源孔
RJ45 網路線*	接到 RJ45 網路線
GND	接地線
Alarm-in	外接警報裝置用
Alarm-out	外接警報裝置用
RESET	將其與接地線纏在一起，即會將攝影機設定重設回原廠設定值

\* 若要使用 PoE (IEEE802.3af) 的安裝方式，請確認網路線的抗阻最大為 20Ω，例如 CAT.5e 或 CAT.6 的網路線，以確保符合 IEEE802.3af 的規範。



## ■ 手動調整鏡頭焦距和焦距 (僅供特定型號使用)

備註：調整鏡頭焦距的適當溫度為 0°C ~ 40°C，並請勿在潮溼處調整。

步驟 1：鬆開外遮罩螺絲以取下外遮罩，然後旋轉並取下前蓋。

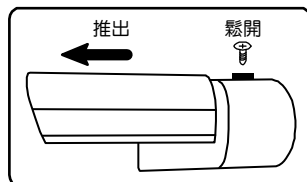

步驟 2：拿出原本放在裡面的防潮包，共兩包。

備註：請記住防潮包原本放的位置，之後會需要將新的防潮包放回原處。

步驟 3：取下前蓋後，會看到兩個調整把手，一個調整焦距，另一個則是調整影像清晰度。靠近攝影機主板的把手是用來調整焦距，確認監視範圍；而靠近攝影機鏡頭的把手，則是用來調整焦距，確認影像清晰度。

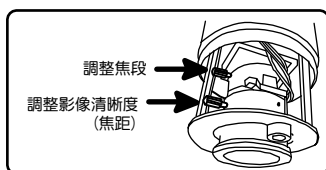

步驟 4：打開配件附的防潮包，然後在 30 秒內放入舊防潮包放的位置，以避免吸收太多水氣使得防潮包失效。

秘訣：如需得知防潮包是否失效，請將防潮包面著光尋找一顆有顏色的防潮粒。若為黃色，則防潮包沒問題；若為綠色或變成紅色，則防潮包已失效，請立即更換。

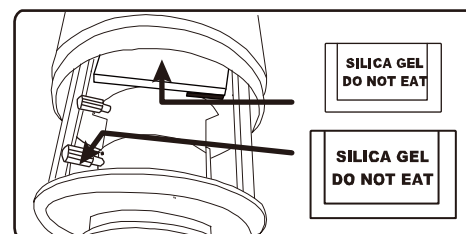

步驟 5：裝回前蓋並鎖緊。

步驟 6：裝回外遮罩，然後鎖緊。

## ■ 插入 Micro SD 記憶卡

只有特定型號才支援安裝 micro SD 記憶卡進行本機錄影。

將 micro SD 記憶卡插入攝影機後，原本儲存在內的資料會自動被清除。

攝影機並不支援熱插拔。在插入 micro SD 記憶卡前，請先中斷攝影機電源。

請依下圖指示插入 micro SD 記憶卡：

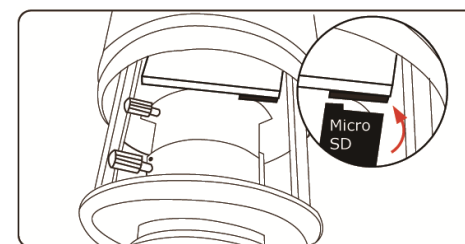

備註：建議可使用鑷子來插入或取出 micro SD 記憶卡，比較方便。

## ■ 攝影機設定

如需設定攝影機進階功能，請確認攝影機已連到同品牌的 NVR，例如下圖。

備註：本產品建議搭配同品牌的 NVR 使用，以達到最佳的相容性。如需單機使用，請另參閱攝影機的操作說明書，以得知如何單獨設定攝影機。

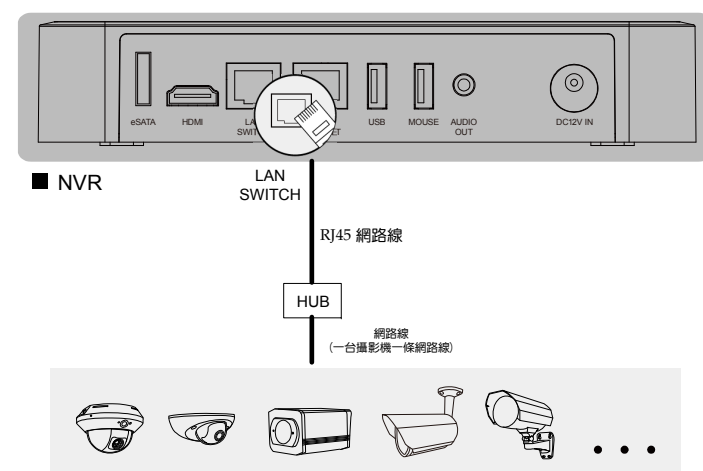

步驟 1：使用 RJ45 網路線，將您的電腦接到攝影機連接的同一台 HUB。



步驟 2：在電腦使用 IPScan.exe 搜尋可用裝置；若要安裝 IPScan.exe，請至隨附光碟取得，或者至 [www.surveillance-download.com/user/IPscan.zip](http://www.surveillance-download.com/user/IPscan.zip) 下載。

步驟 3：搜尋完後，將電腦的網域設成和攝影機相同的網域。以下圖為例，電腦則需設成 192.168.30.xxx" (xxx 介於 0~255)。

IP	Port	Type	Mac
192.168.30.1	88	IP CAMERA (FIX)	00:19:94:25:78:4f
<b>192.168.30.1</b>		IP CAMERA (FIX)	00:18:94:25:77:4f
192.168.30.4	88	IP CAMERA (FIX)	00:17:94:25:76:4f
192.168.30.5	88	IP CAMERA (FIX)	00:16:94:25:75:4f
192.168.30.6	88	IP CAMERA (FIX)	00:15:94:25:74:4f
			00:14:94:25:73:4f

步驟 4：記下您要登入的攝影機 IP 位址和埠號，例如上圖的 192.168.30.1 和 88。

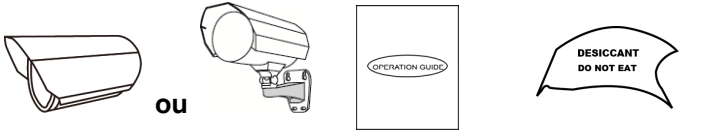
步驟 5：在電腦開啓 Internet Explorer，然後在 URL 欄輸入攝影機的 IP 位址和埠號，格式為 [http://ip 位址:埠號](http://ip位址:埠號)。以上圖為例，則需輸入 <http://192.168.30.1:88>。

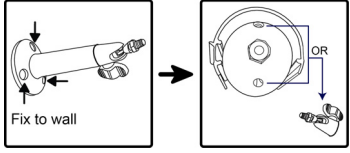
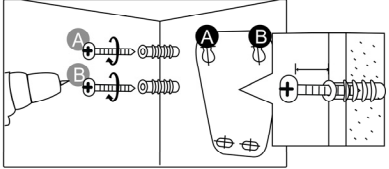
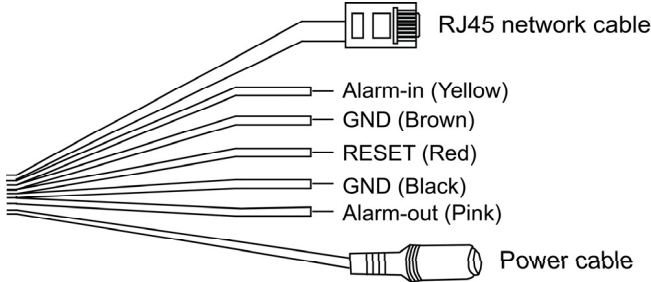
	<h2>■ CONTENU</h2>	<h2>■ INSTALLATION (Type 1)</h2>																					
<div data-bbox="222 426 943 575" style="text-align: center;">  <p><b>Installation Rapide</b></p> </div> <p data-bbox="205 647 960 736">Veuillez lire les instructions attentivement avant toute utilisation. Conservez précieusement cette notice pour une consultation future.</p> <p data-bbox="205 768 927 857">Le manuel d'utilisateur complet est téléchargeable sur le site <a href="http://www.cpcamcctv.fr">www.cpcamcctv.fr</a> ou <a href="http://www.surveillance-download.com/user/m359a.swf">www.surveillance-download.com/user/m359a.swf</a></p>	<p data-bbox="998 282 1629 349">Avant toute installation, veuillez vérifier le contenu de l'emballage.</p> <div data-bbox="1037 401 1750 600">  <p data-bbox="1059 566 1155 591">Caméra</p> <p data-bbox="1190 494 1223 517">ou</p> <p data-bbox="1369 566 1750 591">Guide rapide Déshumidificateur</p> </div> <p data-bbox="1029 647 1355 672"><b>Et pour certains modèles:</b></p> <div data-bbox="1059 703 1690 896">  <p data-bbox="1092 865 1127 890">Vis</p> <p data-bbox="1223 865 1333 890">Chevilles</p> <p data-bbox="1393 865 1503 890">Clé Allen</p> <p data-bbox="1594 865 1690 890">Support</p> </div>	<p data-bbox="1808 282 2444 349">Etape1: Fixez le support à l'endroit où la caméra sera installée, avec les vis et chevilles fournis.</p> <p data-bbox="1808 372 2464 440">Etape2: Desserrez la vis du support afin de détacher la partie amovible, puis visser la caméra dessus.</p> <div data-bbox="1904 469 2252 620">  </div> <p data-bbox="1808 664 2491 732">Etape3: Remettez l'ensemble caméra-partie amovible sur le support et sécurisez en serrant la vis.</p> <p data-bbox="1808 755 2403 823">Etape4: Connectez le câble réseau et alimenter la caméra.</p>																					
<h2>■ INSTALLATION (Type 2)</h2>	<h2>■ CABLAGE</h2>																						
<p data-bbox="244 1058 916 1180">Etape1: Coller le sticker d'installation au mur, puis percez des trous à la position indiquée. Fixez les deux vis supérieures, en laissant un peu d'espace entre le mur et la tête de vis.</p> <div data-bbox="343 1193 729 1360">  </div> <p data-bbox="244 1373 908 1462">Etape2: Accrochez la caméra au deux vis déjà plantées et en vérifiez la solidité et le passage du câble avant de les fixer à fond.</p> <p data-bbox="244 1481 908 1539">Etape3: Vissez les deux vis d'en-bas. Et assurez que la caméra ne bouge pas.</p> <p data-bbox="244 1547 880 1572">Etape4: Ajustez l'angle de vue à l'aide de la clé Allen.</p>	<p data-bbox="1009 1058 1649 1116">Ci-dessus les différents câbles de la caméra. Veuillez consulter le tableau ci-contre pour plus.</p> <div data-bbox="1009 1166 1657 1445">  </div>	<table border="1" data-bbox="1767 1074 2568 1493"> <thead> <tr> <th>Couleur</th> <th>Câble</th> <th>Description</th> </tr> </thead> <tbody> <tr> <td>--</td> <td>Câble d'alimentation</td> <td>Alimentation DC12V.</td> </tr> <tr> <td>--</td> <td>Câble RJ45*</td> <td>Connexion réseau.</td> </tr> <tr> <td>Noir &amp; Marron</td> <td>GND</td> <td>Masse</td> </tr> <tr> <td>Jaune</td> <td>Alarm-in</td> <td>Connexion d'entrée alarme</td> </tr> <tr> <td>Rose</td> <td>Alarm-out</td> <td>Connexion de sortie alarme</td> </tr> <tr> <td>Rouge</td> <td>RESET</td> <td>Court-circuiter ce fil avec la masse pour réinitialiser la caméra à la configuration par défaut d'usine</td> </tr> </tbody> </table> <p data-bbox="1778 1586 2527 1669">* Pour une alimentation PoE (IEEE802.3af), vérifiez la résistance du câble qui ne doit pas dépasser 20 Ω, comme les câbles CAT.5e ou CAT.6, conformément au standard IEEE802.3af.</p>	Couleur	Câble	Description	--	Câble d'alimentation	Alimentation DC12V.	--	Câble RJ45*	Connexion réseau.	Noir & Marron	GND	Masse	Jaune	Alarm-in	Connexion d'entrée alarme	Rose	Alarm-out	Connexion de sortie alarme	Rouge	RESET	Court-circuiter ce fil avec la masse pour réinitialiser la caméra à la configuration par défaut d'usine
Couleur	Câble	Description																					
--	Câble d'alimentation	Alimentation DC12V.																					
--	Câble RJ45*	Connexion réseau.																					
Noir & Marron	GND	Masse																					
Jaune	Alarm-in	Connexion d'entrée alarme																					
Rose	Alarm-out	Connexion de sortie alarme																					
Rouge	RESET	Court-circuiter ce fil avec la masse pour réinitialiser la caméra à la configuration par défaut d'usine																					

## REGLAGE DE L'OUVERTURE ET LA MISE AU POINT (selon modèle)

Note: L'opération d'ajustement doit s'effectuer à une température comprise entre 0°C ~ 40°C, et dans un environnement sec.

Etape1: Desserrez la vis de fixation du couvercle, puis faites glisser pour le déposer. Tourner l'avant de la caméra pour enlever cette partie et accéder aux manettes de réglage.

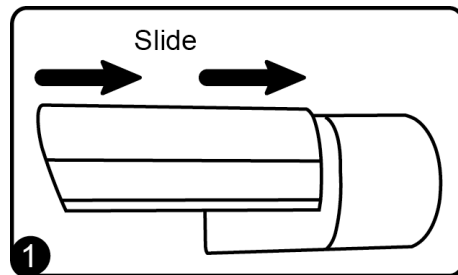

Etape2: Ajuster d'abord la manette Focale pour régler l'ouverture et obtenir le champ de vision voulu puis la manette de mise au point pour ajuster la netteté de l'image (voir figure 2).

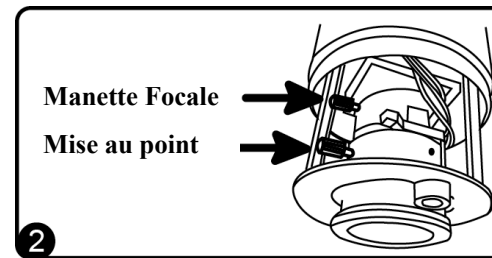

Etape3: Remplacez le déshumidificateur déjà en place par celui que vous trouverez dans l'emballage.



Etape4: Remettre la partie avant.

Etape5: Remettez le couvercle en la glissant et fixez-le avec la vis.

## Insertion Carte Micro SD

Certains modèles possèdent un lecteur de carte micro SD, qui permet l'enregistrement local de la vidéo.

Les données sauvegardées sur la carte seront effacées lors de l'insertion.

Le lecteur n'est pas compatible hot-swap. Veuillez débrancher l'alimentation avant d'insérer ou enlever la carte micro SD.

Veuillez respecter le sens d'insertion et ne pas forcer.

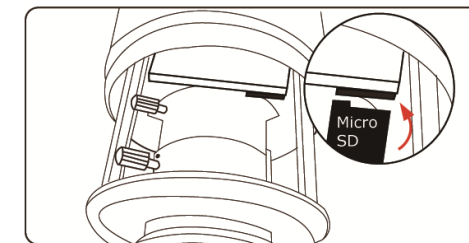

Note: Il est recommandé d'utiliser une pincette pour cette opération.

## CONFIGURATION AVANCEE DE LA CAMERA

Connectée à un NVR, la caméra est configurée automatiquement. Mais la modification de certains paramètres avancés de la caméra nécessite un PC.

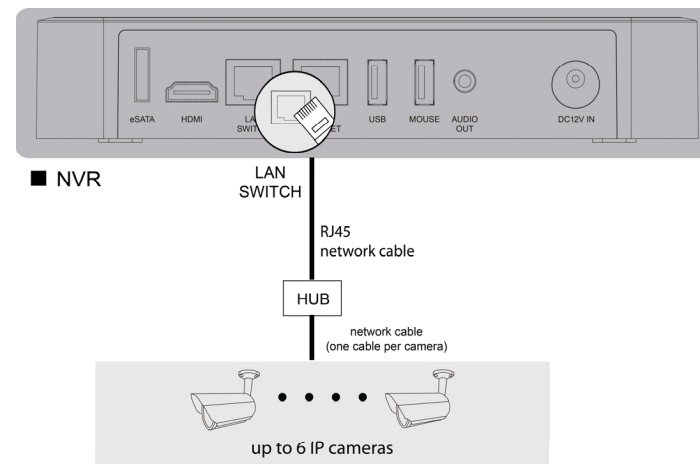

Etape1: Connectez un PC au SWITCH/HUB auquel la caméra est connectée.

Etape2: Recherchez la caméra à l'aide de l'outil "IPScan.exe"; téléchargeable sur [www.surveillance-download.com/user/IPscan.zip](http://www.surveillance-download.com/user/IPscan.zip)

Etape3: Modifiez les paramètres réseau du PC pour qu'il se trouve dans le même sous réseau

IP	Port	Type	Mac	
192.168.30.1	88	IP CAMERA (FIX)	00:19:94:25:78:4f	Configure
192.168.30.1	88	IP CAMERA (FIX)	00:18:94:25:77:4f	Upgrade
192.168.30.1	88	IP CAMERA (FIX)	00:17:94:25:76:4f	Scan
192.168.30.4	88	IP CAMERA (FIX)	00:16:94:25:75:4f	
192.168.30.5	88	IP CAMERA (FIX)	00:15:94:25:74:4f	
192.168.30.6	88	IP CAMERA (FIX)	00:14:94:25:73:4f	Exit

Etape4: Double-cliquez sur la caméra pour y accéder via votre navigateur.

Etape5: Accédez aux menus de configuration pour modifier les paramètres.

Note : Consulter le manuel complet pour connaître d'autres moyens d'accéder à la caméra.

## Guía rápida

Por favor, lea las instrucciones antes de la operación y consérvelo para consultarlo a futuro. Descargar manual en línea:

[www.surveillance-download.com/user/m359a.swf](http://www.surveillance-download.com/user/m359a.swf)

## CONTENIDO DEL PAQUETE

Antes de comenzar a configurar su cámara, asegúrese de que la caja contenga los siguientes elementos:

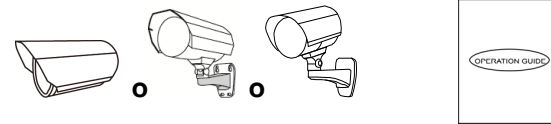

Camara

Guía rápida

### Accesorios opcionales\*:



Tornillos

Taquetes

Llaves

Soporte

Desecante

\*pueden variar dependiendo el modelo

## INSTALACIÓN (Tipo 1)

Paso1: Fijar el soporte a la cámara que desea instalar con los tres tornillos suministrados.

Paso2: Quite la junta del soporte. A continuación, conecte la junta a la parte trasera de la cámara

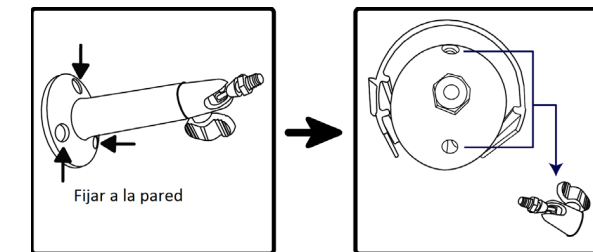

Paso3: Conecte la cámara con la junta conectada al soporte. Después de eso, asegúrese que la junta quede fija. A continuación, fijar el protector de la cámara girando el tornillo pequeño suministrado en cualquiera de los orificios de la cámara.

Paso4: Conectar la cámara a la corriente eléctrica.

## INSTALACIÓN (Tipo 2)

Paso1: Ponga la etiqueta engomada donde desea instalar la cámara. A continuación, perforo y coloque dos tornillos en la parte superior de la pared, como se muestra en la imagen: (A y B)

**Nota:** Deje algo de espacio entre los tornillos y la pared para enganchar el soporte posterior.

Paso2: Cuelgue la cámara en los tornillos que acaba de fijar, y asegúrese de que la cámara se queda en su lugar. Decida la dirección del cable (arriba / abajo) antes de que apriete los tornillos a la pared.

Paso3: Perfore y coloque el resto de los tornillos y asegúrese que todos queden bien ajustados.

Paso4: Ajuste los ángulos verticales y horizontales de la cámara con las llaves suministradas para una mejor visualización..

**Nota:** Para ajustar el ángulo, por ejemplo, el ángulo vertical, / fijar un lado del tornillo a la vez hasta terminar. Por favor, haga el ajuste por turnos por ambos lados hasta que el ángulo quede fijo. De lo contrario, el ángulo de la cámara no podrá fijarse.

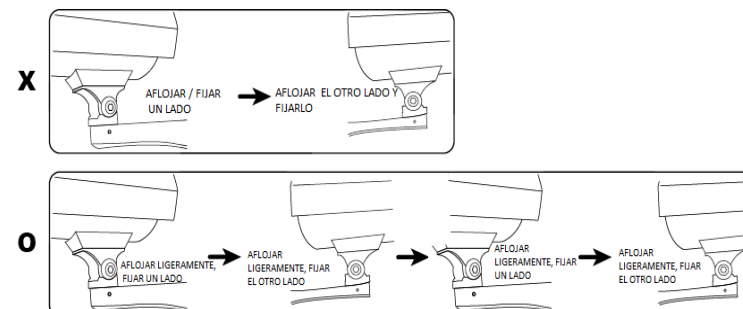
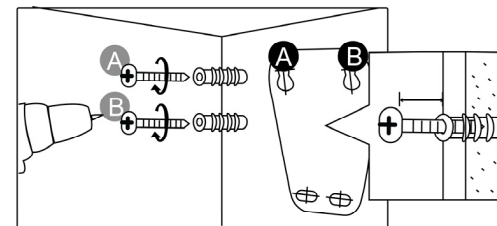

## DESCRIPCIÓN DE CABLES

A continuación se muestra una visión general de varios cables que se pueden utilizar con la cámara. Además, es seguido por una tabla, que ofrece descripciones simples de los cables de conexión

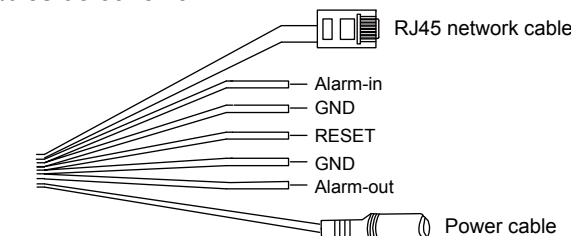

Cable	Description
Power cable	DC12V Fuente de alimentación.
RJ45 network cable*	Se conecta a un cable RJ45
GND	Cable a tierra
Alarm-in	Reservado para la conexión de dispositivos externos de alarma
Alarm-out	Reservado para la conexión de dispositivos externos de alarma
RESET	Retirando el aislante del cable y torciéndolo junto con un cable de tierra, se reestablece la cámara por defecto.

\* Para la instalación PoE (IEEE 802.3af), asegúrese de que el cable de red tenga la resistencia máxima del cable de 20Ω, como CAT.5e o CAT.6 cables, para cumplir con el estándar de IEEE 802.3af.



## ■ AJUSTAR LONGITUD FOCAL y FOCUS (Sólo modelos seleccionados)

**Nota:** La temperatura adecuada para el ajuste del enfoque es de 0 ° C ~ 40 ° C, evite el ajuste en ambiente húmedo.

Paso1: Afloje el tornillo, tomar la cubierta de la cámara, y gire la tapa frontal para extraerla

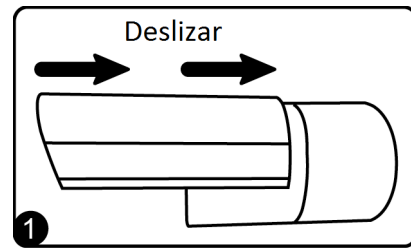

Paso 2: Busque dos manijas en la cámara para ajustar la distancia focal y el focus. Mueva el mango cerca de la placa base primero para encontrar la mejor zona de vigilancia, y mueva la mano cerca de la lente para ajustar la nitidez de la imagen.

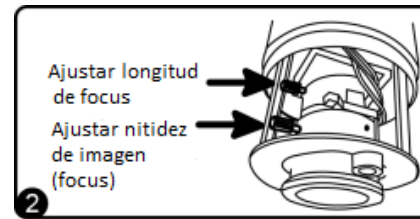

Paso3: Reemplazar la vieja desecante por una nueva, suministrada en el paquete.

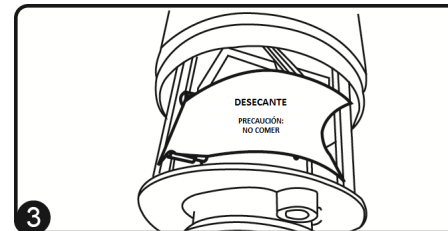

Paso 4: Coloque la cubierta frontal.

Paso 5: Deslice para montar la cubierta de la cámara antes de apretar el tornillo.

## ■ Insertar la tarjeta Micro SD

Sólo modelos seleccionados están equipados con una ranura para tarjeta micro SD para grabación de vídeo local.

Los datos originalmente almacenados en la tarjeta SD micro (si los hay) se eliminarán después de insertarla en la cámara. La cámara no admite hot-swapping. Por favor, insertar o extraer la tarjeta micro SD con la alimentación desconectada.

Por favor, siga las instrucciones en el siguiente gráfico para insertar la tarjeta Micro SD correctamente:

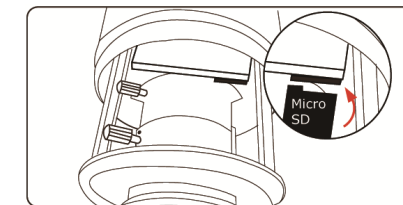

*Nota: Se recomienda el uso de un par de pinzas para la inserción / extracción de la tarjeta Micro SD.*

## ■ CAMERA CONFIGURATION

Para la configuración avanzada de la cámara, asegúrese de que ha conectado la cámara al NVR como se muestra a continuación:

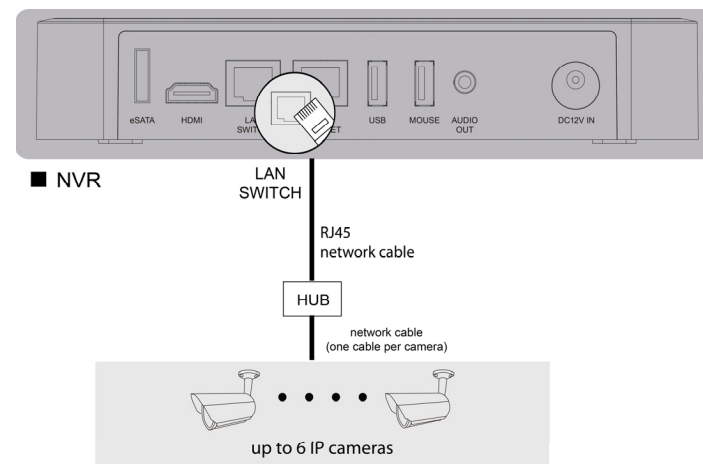

Paso1: Conecte la PC al mismo switch donde están conectadas las cámaras con conector RJ45

Paso 2: Busque dispositivos disponibles con "IPScan.exe"; para descargar "IPScan.exe", por favor visite [www.surveillance-download.com/user/IPscan.zip](http://www.surveillance-download.com/user/IPscan.zip)

Paso 3: Después de buscar, configurar la PC en el mismo segmento de red que la cámara a la que desea acceder, por ejemplo, "192.168.30.xxx" (xxx puede ser de 0 a 255) en nuestro ejemplo:

IP	Port	Type	Mac	
192.168.30.1	88	IP CAMERA (FIX)	00:19:94:25:78:4f	Configure
192.168.30.1	88	IP CAMERA (FIX)	00:18:94:25:77:4f	Upgrade
192.168.30.4	88	IP CAMERA (FIX)	00:17:94:25:76:4f	Scan
192.168.30.5	88	IP CAMERA (FIX)	00:16:94:25:75:4f	
192.168.30.6	88	IP CAMERA (FIX)	00:15:94:25:74:4f	
				Exit

Paso 4: Anote la dirección IP y número de puerto de la cámara que desea tener acceso, como "192.168.30.1" y "88" en nuestro ejemplo.

Paso 5: Abra Internet Explorer en el PC, y escriba la dirección IP y número de puerto en la columna de la dirección URL para acceder a la cámara. El formato es http://direcciónIP:puerto, como http://192.168.30.1:88 en nuestro ejemplo.



## Guida rapida

Leggere attentamente le istruzioni e conservarle per riferimenti futuri. Link per scaricare il manuale Online:  
[www.surveillance-download.com/user/m359a.swf](http://www.surveillance-download.com/user/m359a.swf)

## CONTENUTO CONFEZIONE

Prima di installare la telecamera, assicurarsi di avere tutto il materiale all'interno della confezione:

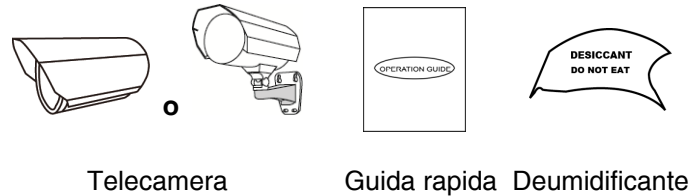

### Solo alcuni modelli:

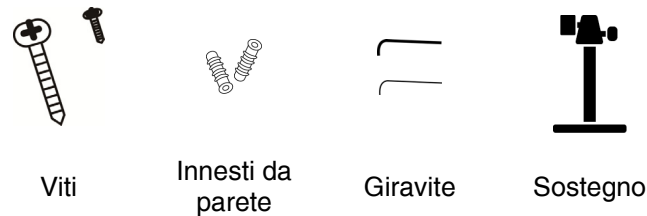

## INSTALLAZIONE (Tipo 1)

Fase1: Fissare il sostegno nel punto in cui si desidera installare la telecamera utilizzando le viti a disposizione.

Fase2: Rimuovere il finale del sostegno e avvitarlo sul retro della telecamera.

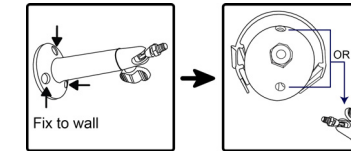

Fase3: Riavvitare il finale del sostegno insieme alla telecamera al resto del sostegno e assicurarlo girando la vite. Avvitare il tettuccio alla telecamera.

Fase4: Infine collegare l'alimentatore della telecamera.

## INSTALLAZIONE (Tipo 2)

Fase1: Applicare l'adesivo nel punto in cui si intende installare la telecamera. Quindi, inserire le due viti più in alto come mostrato nell'immagine.  
*Note: Non girare la vite fino in fondo, lasciare un po di spazio per agganciare la telecamera.*

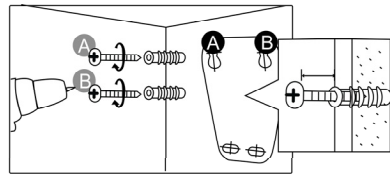

Fase2: Agganciare la telecamera alle viti sulla parete, ed assicurarsi che non si muova. Decidere in anticipo dove fare passare i cavi (sopra / sotto) prima di stringere le viti.

Fase3: Fare altri fori per le restanti viti e stringerle fino in fondo.

Fase4: Regolare l'angolazione della telecamera, quindi utilizzare i giraviti inclusi per fissare la base della telecamera in modo che non si muova.

## COLLEGAMENTO CAVI

Nell'immagine e' possibile vedere la descrizione di tutti i cavi della telecamera, nella tabella a destra si specifica l'utilizzo di ciascun cavo.

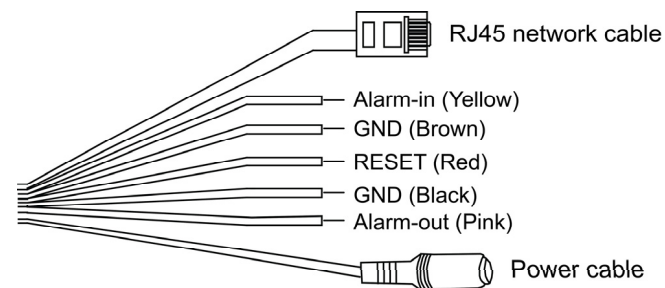

Colore	Cavo	Descrizione
--	Power cable	Alimentatore DC12V.
--	RJ45 network cable*	Collegare ad un cavo di rete RJ45.
Nero / marrone	GND	Messa a terra
Giallo	Alarm-in	Collegare ad un dispositivo di allarme esterno
Rosa	Alarm-out	Collegare ad una sirena o dispositivo di uscita allarme.
Rosso	RESET	Unire questo cavo al cavo GND ed accendere la telecamera per resettare tutti i dati a default.

\* Per installazioni PoE (IEEE802.3af), assicurarsi che il cavo di rete abbia una resistenza massima di 20Ω, ad esempio cavi CAT.5e o CAT.6, per essere adatti allo standard IEEE802.3af.

## REGOLARE LE LENTI E LA MESSA A FUOCO (Solo alcuni modelli)

Note: La temperatura appropriata per regolare la messa a fuoco e' di 0°C ~ 40°C, evitare ambienti umidi per effettuare l'operazione.

Fase1: Svitare la vite e rimuovere il tettuccio, quindi svitare la parte anteriore della telecamera.

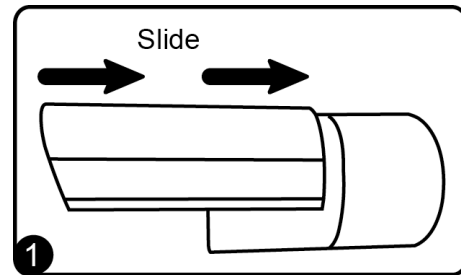

Fase2: Individuare le due viti per la regolazione della messa a fuoco. Puntare la telecamera sulla zona da monitorare quindi muovere le viti per ottenere la messa a fuoco corretta.

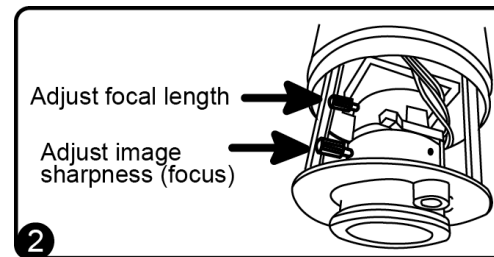

Fase3: Sostituire il deumidificante con uno nuovo disponibile nella confezione.



Fase4: Riavvitare la parte anteriore.

Step5: Riapplicare il tettuccio e assicurarlo con la vite alla telecamera.

## Inserire la scheda Micro SD

Solo alcuni modelli dispongono di uno spazio per scheda SD.

Tutti i dati presenti nella scheda micro SD card (se presenti) verranno rimossi durante l'installazione.

La telecamera non supporta la funzione di hot-swapping. Quindi inserire la tessera micro SD solo quando la telecamera e' spenta. Seguire l'illustrazione in basso per inserire correttamente la scheda Micro SD:

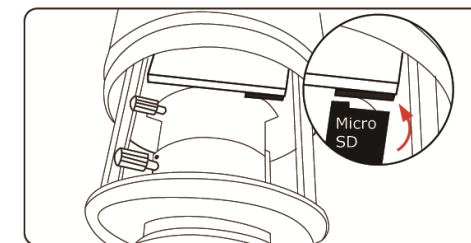

Note: Si raccomanda di utilizzare una graffetta o un asticella per inserire o rimuovere la scheda Micro SD dal suo alloggiamento.

## CONFIGURAZIONE TELECAMERA

Verificare che la telecamera sia stata collegata all' NVR come nell'immagine in basso:

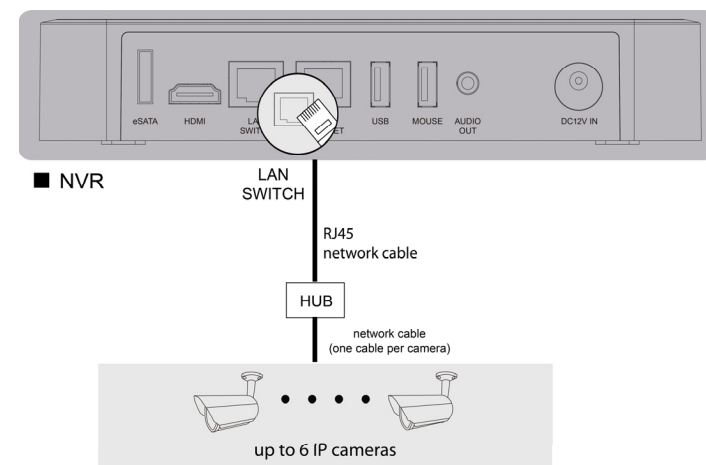

Fase1: Collegare il proprio PC al HUB/modem al quale e' collegata la telecamera con cavo di rete RJ45.

Fase2: Utilizzare il programma "IPScan.exe" per individuare l'indirizzo IP; per scaricare "IPScan.exe": [www.surveillance-download.com/user/IPscan.zip](http://www.surveillance-download.com/user/IPscan.zip)

Fase3: Una volta completata la ricerca, impostare nel proprio PC un indirizzo IP con lo stesso dominio della telecamera, ad esempio "192.168.30.xxx" (xxx puo essere 0~255)

IP	Port	Type	Mac
192.168.30.1	88	IP CAMERA (FIX)	00:19:94:25:78:4f
<b>192.168.30.1</b>		IP CAMERA (FIX)	00:18:94:25:77:4f
192.168.30.4	88	IP CAMERA (FIX)	00:17:94:25:76:4f
192.168.30.5	88	IP CAMERA (FIX)	00:16:94:25:75:4f
192.168.30.6	88	IP CAMERA (FIX)	00:15:94:25:74:4f

Fase4: Segnare l'indirizzo IP e il numero di porta della telecamera, ad esempio "192.168.30.1" e "88".

Fase5: Aprire Internet Explorer nel proprio PC, e inserire l'indirizzo IP e il numero di porta nell'area indirizzi URL per collegarsi alla telecamera. Questo il formato corretto: `http://ipaddress:portnum`, ad es. `http://192.168.30.1:88`.